

Description

The XXW4882 uses advanced trench technology to provide excellent $R_{DS(ON)}$, low gate charge and operation with gate voltages as low as 2.5V. This device is suitable for use as a Battery protection or in other Switching application.

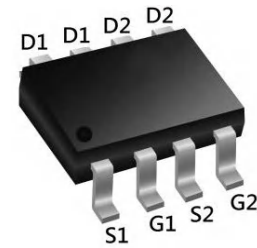

SOP-8

General Features

$V_{DS} = 40V$ $I_D = 8A$

$R_{DS(ON)} < 20m\Omega$ @ $V_{GS}=10V$

Application

Battery protection

Load switch

Uninterruptible power supply

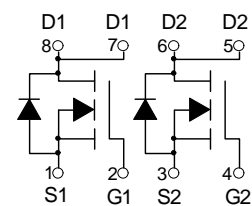

Dual N-Channel MOSFET

Absolute Maximum Ratings@ $T_J=25^\circ C$ (unless otherwise specified)

Symbol	Parameter	Rating	Units
V_{DS}	Drain-Source Voltage	40	V
V_{GS}	Gate-Source Voltage	± 20	V
$I_D@T_A=25^\circ C$	Drain Current, $V_{GS} @ 4.5V^3$	8	A
$I_D@T_A=70^\circ C$	Drain Current, $V_{GS} @ 4.5V^3$	6	A
I_{DM}	Pulsed Drain Current ¹	36	A
$P_D@T_A=25^\circ C$	Total Power Dissipation	1.9	W
T_{STG}	Storage Temperature Range	-55 to 150	$^\circ C$
T_J	Operating Junction Temperature Range	-55 to 150	$^\circ C$
R_{thj-a}	Maximum Thermal Resistance, Junction-ambient ³	40	$^\circ C/W$

Electrical Characteristics (T_J=25 °C, unless otherwise noted)

Symbol	Parameter	Conditions	Min.	Typ.	Max.	Unit
BV _{DSS}	Drain-Source Breakdown Voltage	V _{GS} =0V, I _D =250uA	40	---	---	V
ΔBV _{DSS} /ΔT	BVDSS Temperature Coefficient	Reference to 25°C, I _D =1mA	---	0.032	---	V/°C
R _{DS(ON)}	Static Drain-Source On-Resistance ²	V _{GS} =10V, I _D =7A	---	16	20	mΩ
		V _{GS} =4.5V, I _D =6A	---	20	26	
V _{GS(th)}	Gate Threshold Voltage	V _{GS} =V _{DS} , I _D =250uA	1.2	1.6	2.5	V
ΔV _{GS(th)}	V _{GS(th)} Temperature Coefficient		---	-4.8	---	mV/°C
I _{DSS}	Drain-Source Leakage Current	V _{DS} =32V, V _{GS} =0V, T _J =25°C	---	---	1	uA
		V _{DS} =32V, V _{GS} =0V, T _J =55°C	---	---	5	
I _{GSS}	Gate-Source Leakage Current	V _{GS} =±20V, V _{DS} =0V	---	---	±100	nA
g _{fs}	Forward Transconductance	V _{DS} =5V, I _D =7A	---	32	---	S
R _g	Gate Resistance	V _{DS} =0V, V _{GS} =0V, f=1MHz	---	2.1	---	Ω
Q _g	Total Gate Charge (4.5V)	V _{DS} =32V, V _{GS} =4.5V, I _D =7A	---	9.8	---	nC
Q _{gs}	Gate-Source Charge		---	2.8	---	
Q _{gd}	Gate-Drain Charge		---	3.9	---	
T _{d(on)}	Turn-On Delay Time	V _{DD} =20V, V _{GS} =10V, R _G =3.3Ω I _D =7A	---	2.8	---	ns
T _r	Rise Time		---	40.4	---	
T _{d(off)}	Turn-Off Delay Time		---	22.8	---	
T _f	Fall Time		---	6.4	---	
C _{iss}	Input Capacitance	V _{DS} =15V, V _{GS} =0V, f=1MHz	---	1013	---	pF
C _{oss}	Output Capacitance		---	107	---	
C _{rss}	Reverse Transfer Capacitance		---	76	---	

Diode Characteristics

Symbol	Parameter	Conditions	Min.	Typ.	Max.	Unit
I _S	Continuous Source Current ^{1,5}	V _G =V _D =0V, Force Current	---	---	8	A
I _{SM}	Pulsed Source Current ^{2,5}		---	---	36	A
V _{SD}	Diode Forward Voltage ²	V _{GS} =0V, I _S =1A, T _J =25°C	---	---	1	V
t _{rr}	Reverse Recovery Time	I _F =7A, di/dt=100A/μs,	---	10	---	nS
Q _{rr}	Reverse Recovery Charge	T _J =25°C	---	3.3	---	nC

Note :

- The data tested by surface mounted on a 1 inch² FR-4 board with 2OZ copper.
- The data tested by pulsed, pulse width ≤ 300us, duty cycle ≤ 2%
- The EAS data shows Max. rating. The test condition is V_{DD}=25V, V_{GS}=10V, L=0.1mH, I_{AS}=25A
- The power dissipation is limited by 150°C junction temperature
- The data is theoretically the same as I_D and I_{DM}, in real applications, should be limited by total power dissipation.

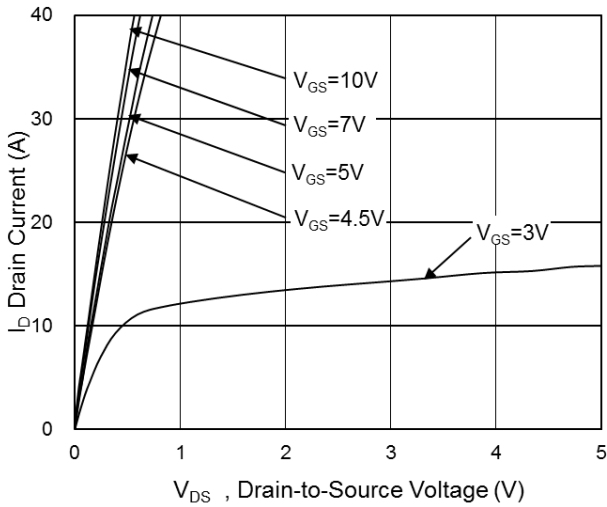
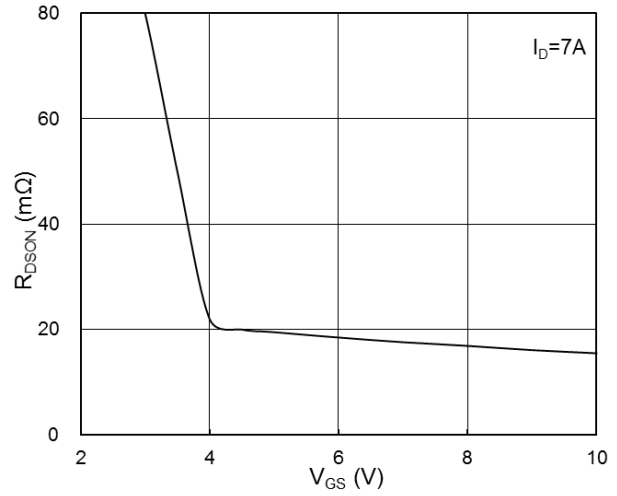
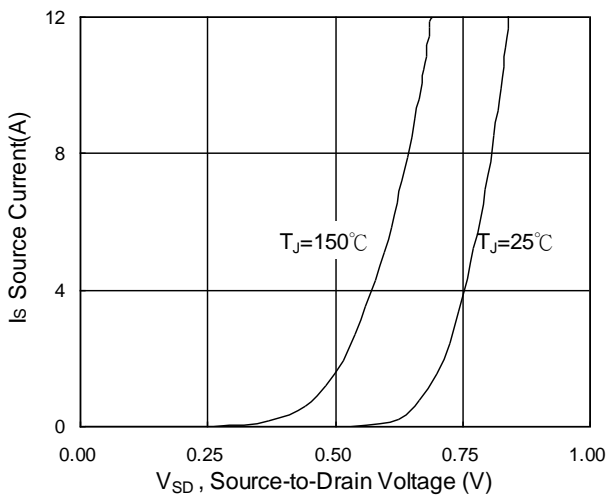
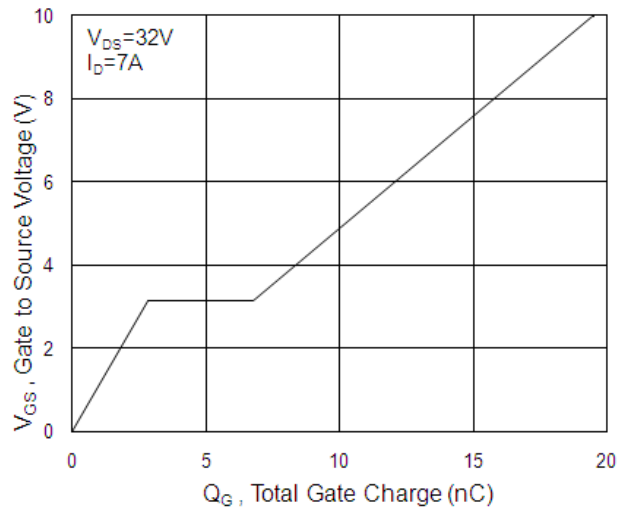
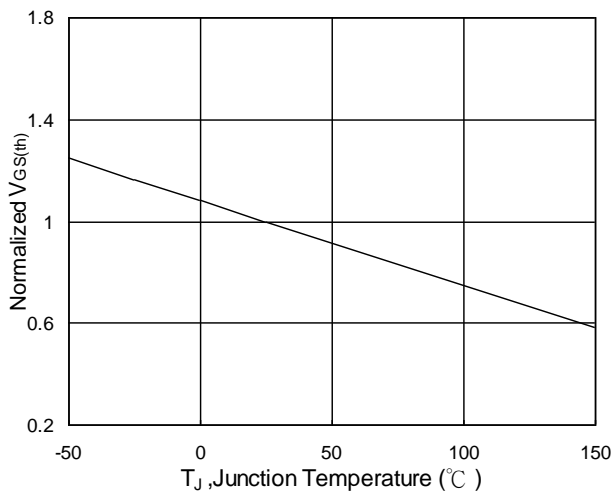
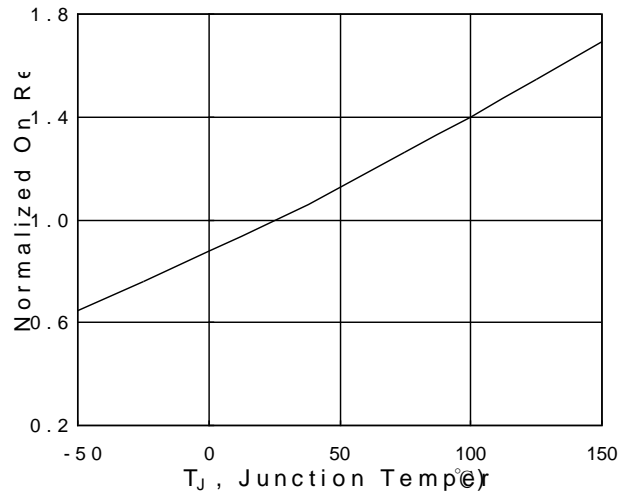
Typical Characteristics

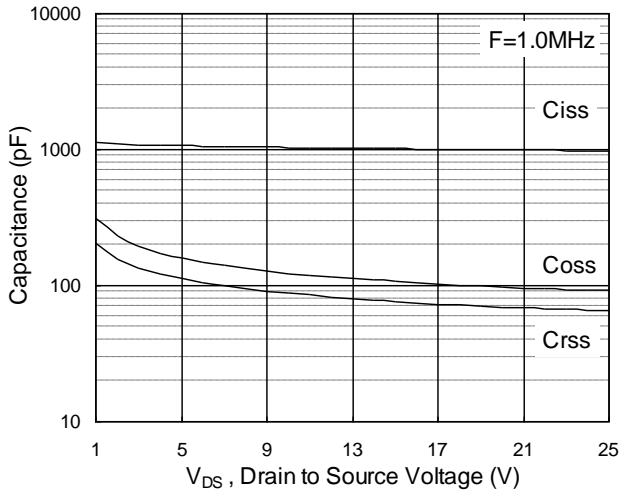
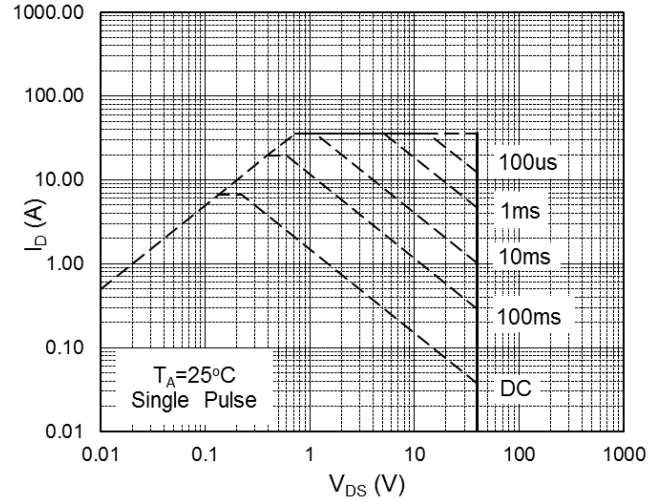
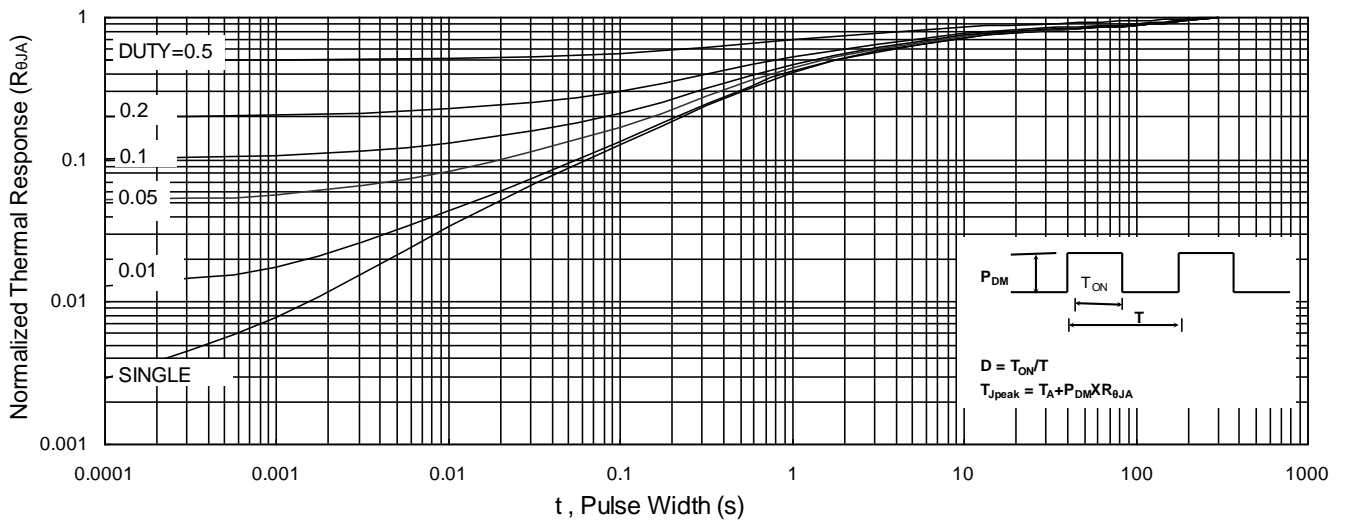
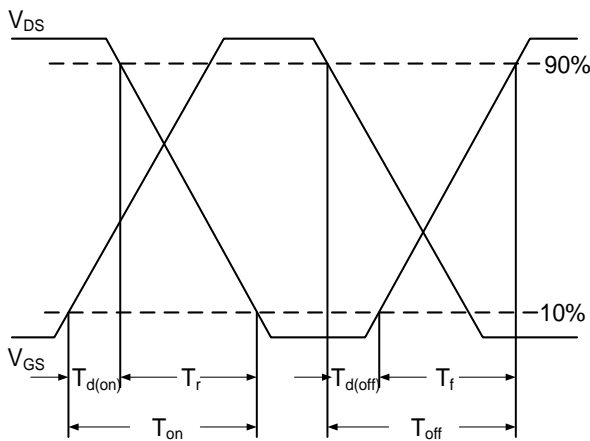
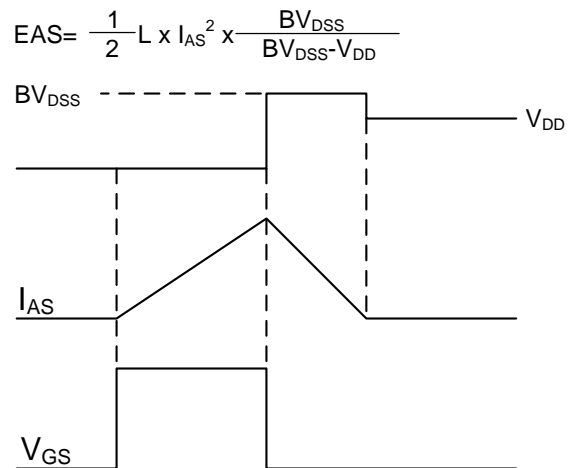
Fig.1 Typical Output Characteristics

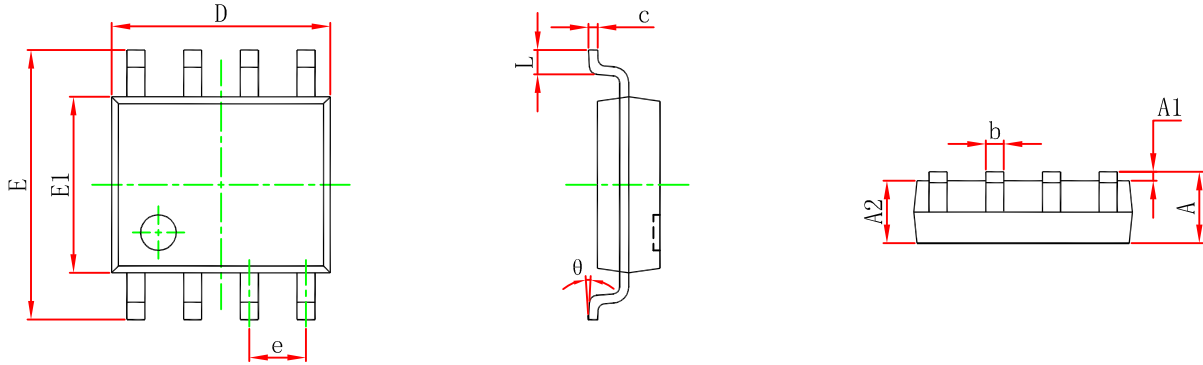
Fig.2 On-Resistance vs. G-S Voltage

Fig.3 Forward Characteristics of Reverse

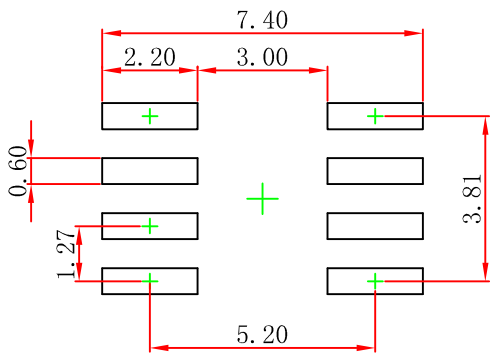
Fig.4 Gate-Charge Characteristics

Fig.5 Normalized $V_{GS(th)}$ vs. T_J

Fig.6 Normalized $R_{DS(on)}$ vs. T_J

Fig.7 Capacitance

Fig.8 Safe Operating Area

Fig.9 Normalized Maximum Transient Thermal Impedance

Fig.10 Switching Time Waveform

Fig.11 Unclamped Inductive Switching Waveform

SOP-8 Package Outline Dimensions

Symbol	Dimensions In Millimeters		Dimensions In Inches	
	Min	Max	Min	Max
A	1.350	1.750	0.053	0.069
A1	0.100	0.250	0.004	0.010
A2	1.350	1.550	0.053	0.061
b	0.330	0.510	0.013	0.020
c	0.170	0.250	0.007	0.010
D	4.800	5.000	0.189	0.197
e	1.270 (BSC)		0.050 (BSC)	
E	5.800	6.200	0.228	0.244
E1	3.800	4.000	0.150	0.157
L	0.400	1.270	0.016	0.050
θ	0°	8°	0°	8°



Note:
 1. Controlling dimension: in millimeters.
 2. General tolerance: $\pm 0.05\text{mm}$.
 3. The pad layout is for reference purposes only.