

3.0Amp Surface Mounted Schottky Barrier Rectifiers
Features

- ◆ The plastic package carries Underwriters Laboratory Flammability Classification 94V-0
- ◆ For surface mounted applications
- ◆ Built-in strain relief, ideal for automated placement
- ◆ Low reverse leakage
- ◆ High forward surge current capability
- ◆ High temperature soldering guaranteed
250°C/10 seconds at terminals

Mechanical Data

Case : Molded plastic body

Terminals : Solder plated, solderable per MIL-STD-750, Method 2026

Polarity : Polarity symbol marking on body

Mounting Position : Any

Weight : 0.0023 ounce, 0.07 grams

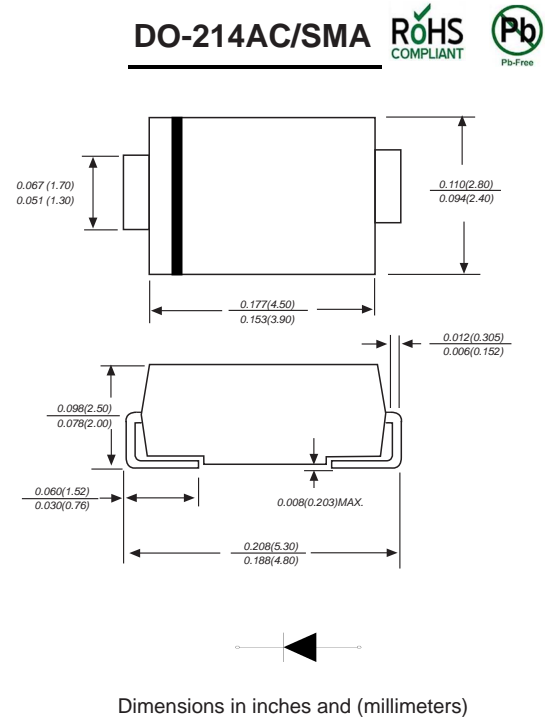
Maximum Ratings And Electrical Characteristics

Ratings at 25°C ambient temperature unless otherwise specified. Single phase half-wave 60Hz, resistive or inductive load, for capacitive load current derate by 20%.

Parameter	SYMBOLS	SS32	SS34	SS36	SS38	SS310	SS315	SS320	UNITS
Maximum repetitive peak reverse voltage	V_{RRM}	20	40	60	80	100	150	200	V
Maximum RMS voltage	V_{RMS}	14	28	42	56	70	105	140	V
Maximum DC blocking voltage	V_{DC}	20	40	60	80	100	150	200	V
Maximum average forward rectified current at $T_L=100^\circ\text{C}$	$I_{(AV)}$	3.0							A
Peak forward surge current, 8.3ms single half sine-wave superimposed on rated load	I_{FSM}	80.0							A
Maximum instantaneous forward voltage at 3.0A	V_F	0.55	0.70	0.85		0.95		V	
Maximum DC reverse current at rated DC blocking voltage $T_A=25^\circ\text{C}$ $T_A=125^\circ\text{C}$	I_R	0.5 50		0.05 10		mA			
Typical thermal resistance	R_{qJA}	80.0							$^\circ\text{C}/\text{W}$
Operating junction temperature range	T_J	-55 to +150			-55 to +175				$^\circ\text{C}$
Storage temperature range	T_{STG}	-55 to +175							$^\circ\text{C}$

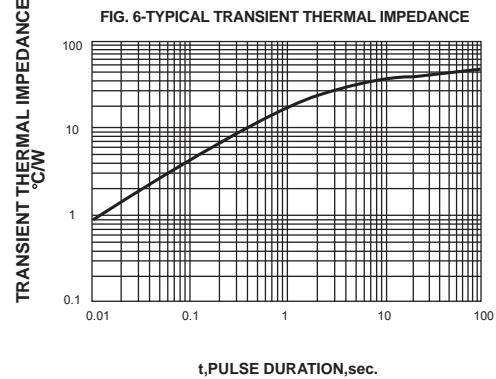
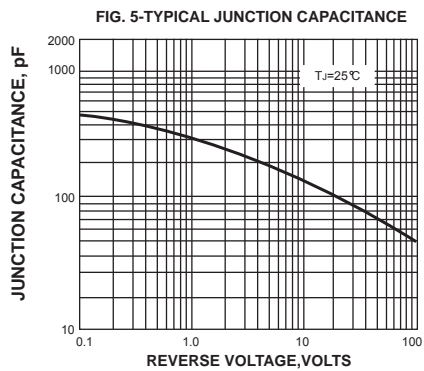
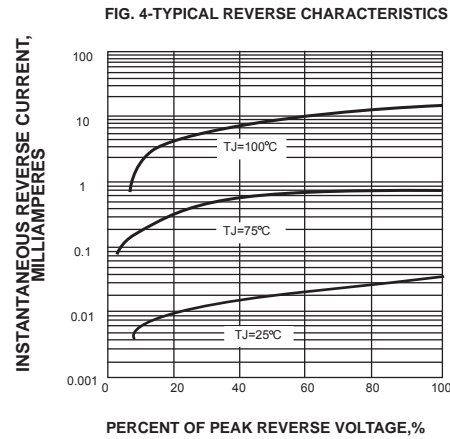
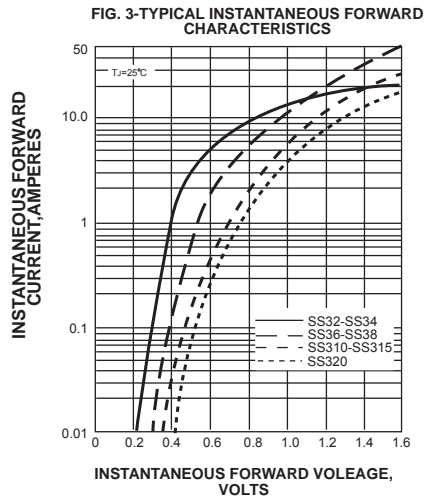
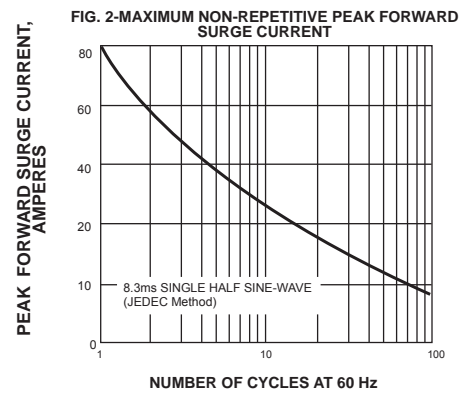
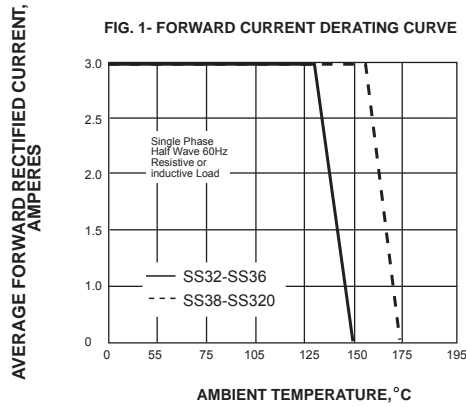
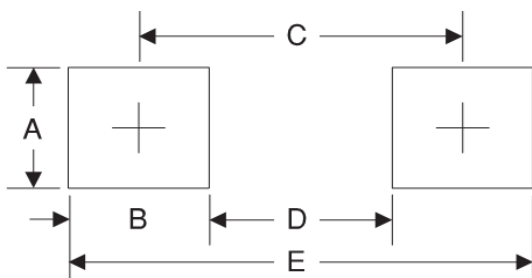
3.0Amp Surface Mounted Schottky Barrier Rectifiers
Ratings And Characteristic Curves

Suggested Pad Layout

Symbol	Unit (mm)	Unit (inch)
A	1.68	0.066
B	1.52	0.060
C	3.90	0.154
D	2.41	0.095
E	5.45	0.215